



WHYNTER ELITE 12,000 BTU DUAL HOSE DIGITAL PORTABLE AIR CONDITIONER

Model # : ARC-122DS

INSTRUCTION MANUAL



Congratulations on your new Whynter product. To ensure proper operation, please read this Instruction Manual carefully before using this product. Keep this manual in a safe place for future reference.

TABLE OF CONTENTS

	<u>PAGE</u>
DISPOSAL INFORMATION	<u>3</u>
SAFETY PRECAUTIONS	<u>4 - 6</u>
INTRODUCTION / TECHNICAL DATA	<u>7</u>
PARTS IDENTIFICATION	<u>8 - 9</u>
CONTROL PANEL	<u>10</u>
INSTALLATION	<u>11 - 12</u>
OPERATION INSTRUCTIONS	<u>13 - 14</u>
REMOTE CONTROL	<u>15</u>
CARE AND MAINTENANCE	<u>16</u>
TROUBLESHOOTING	<u>17 - 18</u>
WARRANTY INFORMATION	<u>19</u>

DISPOSAL INFORMATION

Thank you for choosing the Whynter 12,000 BTU Dual Hose Digital Portable Air Conditioner. Please follow the instructions provided in this user guide to obtain the very best performance from your portable air conditioner and take full advantage of the many features your portable air conditioner offers you. We trust that your Whynter air conditioner will provide the performance and reliability that we stand for.

Please keep this user manual in a safe place for future reference.

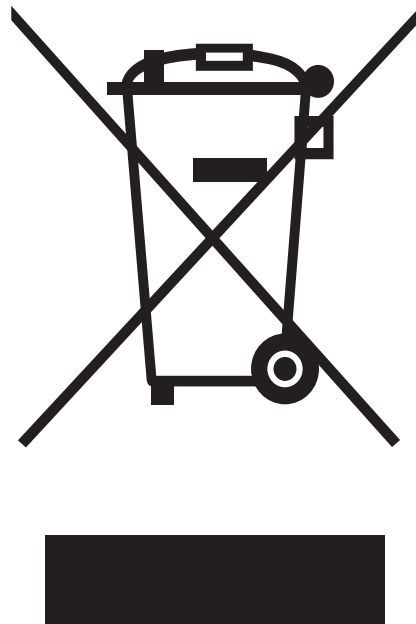

This symbol on the product or its packaging indicates that the appliance cannot be treated as normal domestic trash, but must be handed in at a collection point for recycling electric and electronic appliances. Your contribution to the correct disposal of this product protects the environment. Further information about the recycling of this product can be obtained from your local municipal authority.

SAFETY PRECAUTIONS

WARNING

TO REDUCE THE RISK OF FIRE, ELECTRICAL SHOCK, OR INJURY WHEN USING YOUR AIR CONDITIONER, FOLLOW THESE BASIC PRECAUTIONS:

Before the appliance is used, it must be properly positioned and installed as detailed in this manual.

- Do not under any circumstances cut or remove the third (ground) prong from the power cord
- Make sure this unit is connected to a correctly grounded power supply outlet. Do not use an extension cord or power strip
- The power cord is UL listed. It has a built-in L.C.D.I. (leakage, current, detection, interruption) circuit breaker for added safety. If the power supply is interrupted, press the reset button to reconnect the unit to power source
- It is recommended to use a separate circuit that its size should be 15 Amps for the air conditioner
- Do not use an excessively wet cloth, industrial solvents, oil-based products to clean this portable air conditioner
- To avoid the risk of shock, the product should never be used in bathrooms, shower rooms, or in any other steamy or wet areas
- Do not store or use gasoline or other flammable vapors and liquids in the vicinity of this or any other appliances
- Do not repair, disassemble and/or modify the unit by yourself
- Always turn off the portable air conditioner when cleaning the air filter, and transporting
- Do not turn this unit on and off by plugging and unplugging. Always use the ON/OFF switch
- Transport the unit in an upright position only, or leave it in an upright position for a minimum of 4 hours before first use.
- Ensure curtains or other objects are not obstructing the air inlet filters
- Do not bend or crush the exhaust hose while in use
- Always allow at least 20" of clearance around the unit for ventilation. Do not use this unit inside closets, cabinets and/or cramped spaces between furniture
- This unit is optimized to operate in an ambient temperature of 64°F – 95°F
- This unit must be installed in an area protected from the element, such as wind, rain, water spray or drips
- The unit should not be located next to ovens, grills or other sources of high heat
- Always place the unit on even and hard and level surface
- Do not sit or place objects on the unit
- Do not allow children to climb, stand or hang on the appliance. The air conditioner could tip over and get damaged and/or seriously injure somebody
- Keep fingers out of the air intakes and air outlets
- The appliance is an electrical appliance. To avoid injury from electrical shock do not operate it with wet hands, while standing on a wet surface or while standing in water. Do not use it in outdoors or in wet conditions
- When positioning or moving the appliance, ensure it is not turned upside down or greater than 45° or more off level
- This appliance is designed for household, non-commercial use only. Any other use will void the warranty
- Do not plug into the power outlet before set up is completed
- Do not operate this unit without the air filter(s)
- Do not use harsh chemicals to clean the filter(s). Dry thoroughly before inserting the filter(s) into the unit
- Do not add extra length to the exhaust hose by more than a total length of 9'. This will reduce the cooling efficiency of the portable air conditioner
- At the end of each season, all water must be drained from the unit and filter(s) must be cleaned before storage

THE MANUFACTURER DISCLAIMS ANY RESPONSIBILITY IF THE ABOVE INSTRUCTIONS ARE NOT FOLLOWED.

SAFETY PRECAUTIONS

- Only install and operate this appliance as outlined in this instruction manual. At all times, use care when using this appliance.
- Do not modify this appliance in any way to avoid danger.
- Electrical equipment and installations regulated by national legislation must be followed.
- Children must not use this appliance unsupervised.
- For safety reasons, anyone with psychological, physical or any medical condition that may impair judgment should only use this appliance when under the supervision of a responsible adult.
- For safety sake, never use a damaged power cable; always refer to the manufacturer or an authorized technical service centre if appliance requires repair.
- It is essential that the appliance is connected to an efficient earth system checked by a qualified electrician.
- The use of extension cables is not recommended.
- The Air filter should be cleaned a minimum of once every two weeks.
- Do not place the air conditioner near any heating appliance.
- The appliance should be transported upright or on its side. Any internal circuit water should be emptied before moving. Do not turn on the appliance for at least one hour before starting it.
- Flammable substances or pressurised containers (eg aerosol cans) should be kept a minimum of 50cms away.
- The appliance should not be installed in rooms containing sulphur, gas or oil.
- Do not disconnect the appliance by pulling on the power cable; always disconnect the appliance before any cleaning or maintenance is undertaken.
- Do not store anything on top of the appliance, especially heavy or hot objects.
- Repairs must only be undertaken by authorised service centres of the manufacturer.
Failure to comply may be dangerous.
- Do not store the appliance covered with plastic bags.
- Remember the environment when disposing of packaging around the appliance and when the appliance has reached its used by date.
- A warning that the appliance shall be stored in a well-ventilated area where the room size corresponds to the room area as specified for operation.
- A warning to keep ventilation openings clear of obstruction.
- This appliance can be used by children aged from 8 years and above and persons with reduced physical, sensory or mental capabilities or lack of experience and knowledge if they have been given supervision or instruction concerning use of the appliance in a safe way and understand the hazards involved.
- Children shall not play with the appliance.
- Cleaning and user maintenance shall not be made by children without supervision.
- If the power cord on this unit is damaged it must be replaced by the manufacturer, its service agent or qualified persons in order to avoid a hazard.
- This appliance is not intended for use by children or other persons without assistance or supervision if their physical, sensory or mental capabilities prevent them from using it safely.
Children should be supervised to ensure that they do not play with the appliance.
- This appliance is intended for domestic use only, any other use may invalidate the warranty and might be dangerous.
- Do not pierce or burn.
Use only implements recommended by the manufacturer for defrosting or cleaning.
- Do not use the appliance in a room with continuously operating sources of ignition (eg. Open flames, an operating gas appliance or an operating electrical heaters).
- Do not perforate any of the components in the refrigerant circuit.
- Refrigerant gas may be odorless.

THE MANUFACTURER DISCLAIMS ANY RESPONSIBILITY IF THE ABOVE INSTRUCTIONS ARE NOT FOLLOWED.

SAFETY PRECAUTIONS

- Stagnation of possible leaks of refrigerant gas in unventilated rooms could lead to fire or an explosion hazard should the refrigerant come in contact with electric heaters, stoves or other sources of ignition.
- Use care when storing the appliance to prevent mechanical faults.
- Only persons authorised by an accredited agency certifying their competence to handle refrigerants in compliance with sector legislation should work on refrigerant circuits.
- Maintenance and repairs requiring the assistance of other qualified personnel must be carried out under the supervision of specialists in the use of inflammable refrigerants.

WARNING

Do not use means to accelerate the defrosting process or to clean, other than those recommended by the manufacturer. The appliance shall be stored in a room without continuously operation ignition sources (for example: open flames, an operating gas appliance or an operating electric heater.)

Do not pierce or bum.

Be aware that refrigerants may not contain an odor.

NOTE: The manufacturer may provide other suitable examples or may provide additional information about the refrigerant odor.



Warning: Risk of fire / Flammable materials



User Manual



Service indicator: check User Manual

DANGER – Risk Of Fire Or Explosion. Flammable Refrigerant Used. To Be Repaired Only By Trained Service Personnel. Do Not Puncture Refrigerant Tubing. CAUTION – Risk Of Fire Or Explosion. Dispose Of Properly In Accordance With Federal Or Local Regulations. Flammable Refrigerant Used.



Caution, risk of fire

INTRODUCTION / TECHNICAL DATA

HOW IT WORKS

The Whynter compact CFC-free, lead-free, and energy efficient 12,000 BTU portable air conditioner, helps you stay cool while working with better environmental standards and reducing energy consumption.

This high output portable air conditioner, specially designed to be mobile, can be easily setup in almost any indoor location and is most commonly used in data closets / server rooms, bedrooms, classrooms and garages / workshops.

This Whynter ARC-122DS portable air conditioner features an ECO-FRIENDLY CFC-free GREEN R32 refrigerant and lead-free RoHS compliant components.







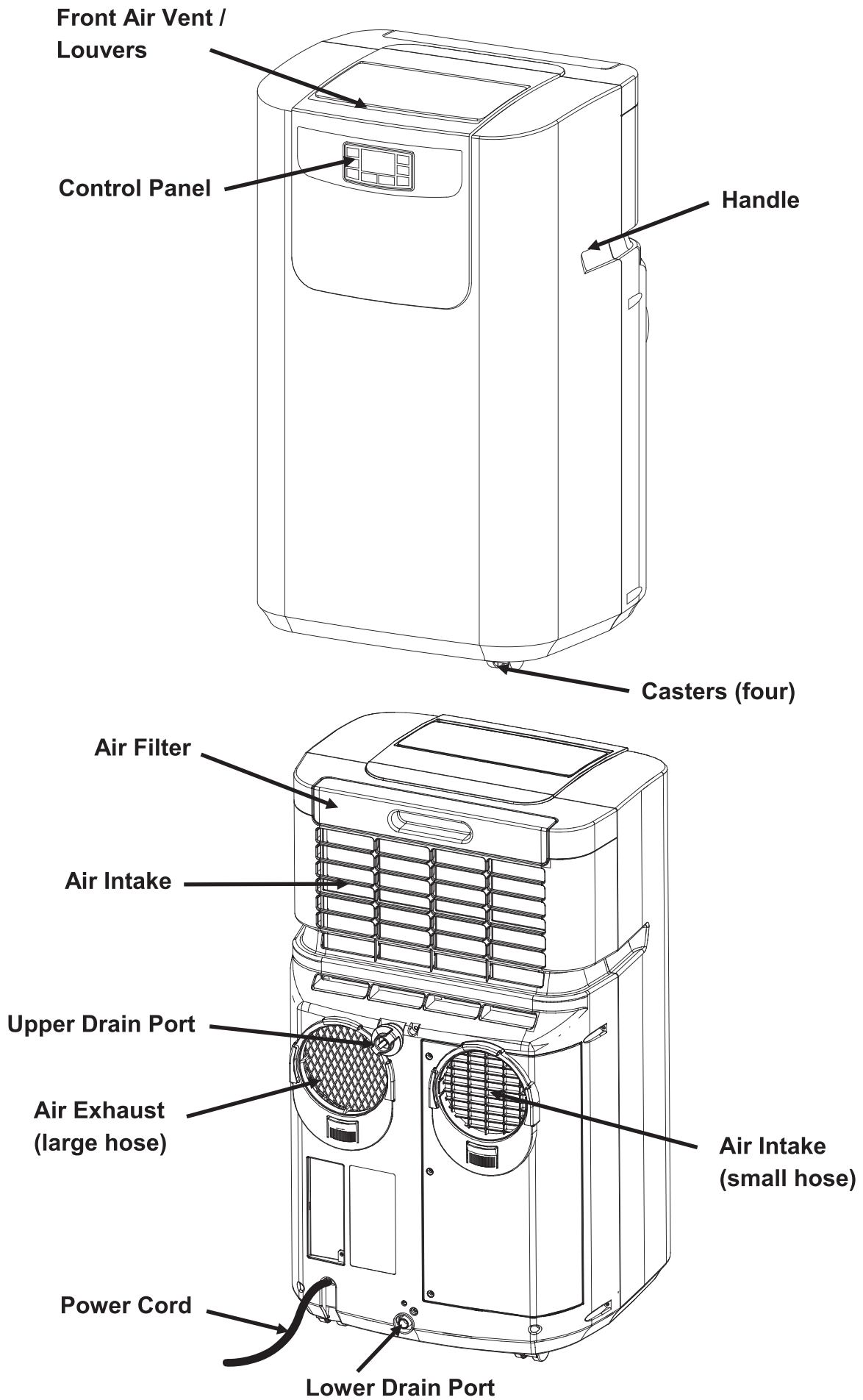



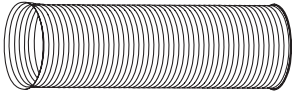
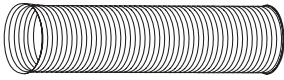

Operationally, a dual hose portable air conditioner has two main advantages over a single hose unit. A dual hose portable air conditioner will cool a room faster and will help minimize negative air pressure situation in the room. If the outside temperature is much higher or more humid than the room, the intake hose can be detached and the unit will function as a single hose unit.

TECHNICAL DATA	
Model:	ARC-122DS
Operational Modes:	Cool, Fan or Dehumidifier
Cooling Capacity:	12,000 BTU (SACC 7,000 BTU)
Dehumidifying Capacity:	82 Pts / day
Fan Speed:	3 Fan Speeds
Filters:	Carbon air filter and washable pre-filter
Thermostat Control Range:	61° - 89°F
Timer:	24 hour programmable timer
Noise Level:	<47 low / <52 high dbA
Refrigerant:	R32
Air Flow (at high speed):	330 m ³ /h / 194 CFM
Maximum Power Consumption:	1200W / 10.5A
Power Supply:	115 V / 60Hz
CEER EER:	6.88 9.15
Unit Dimensions:	17" W x 16" D x 29.5" H
Package Dimensions:	20.5" W x 18.8"D x 35"H
Net Weight:	68 lbs
Gross Weight:	79 lbs
Large Exhaust Hose:	5.9" diameter
Large Hose Connector:	5.9" diameter with 5.0" diameter reducer
Small Intake Hose:	5.0" diameter
Small Hose Connector:	5.0" diameter
Fixture and Window Kit:	5.0" diameter
Window Kit:	6.5" W x 20" (min)/ 46" (max) L

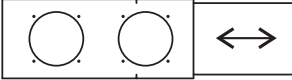
PARTS IDENTIFICATION

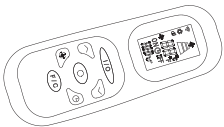

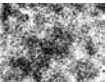
PARTS IDENTIFICATION

IMAGE	ACCESSORY NAME	QUANTITY
	Exhaust hose (large)	1 piece
	Intake hose (small)	1 piece
	Fixtures ** attached to the covers upon unboxing **	2 pieces
	Screws	8 pieces
	1 Large Exhaust Hose Connector to Window Kit with tab cut-outs	1 piece
	1 Large Slide Locking Exhaust Hose Connector to unit	1 piece
	1 Small Slide Locking Intake Hose Connector to unit	1 piece
	1 Small Intake Hose Connector to Window Kit with tab cut-outs	1 piece
	Window slider kit	1 set
	Covers ** attached to the fixtures upon unboxing **	2 pieces
	Remote control	1 piece
	Storage Cover	1 piece
	Carbon Filter	1 piece
	Optional Intake filter (sold separately)	1 piece

** The fixture pieces may come attached to the cover pieces. To remove, twist the cover pieces to allow the tab from the fixtures to disengage from the covers, and twist the covers to remove from the fixtures.

• Note: Please visit whynter.com for optional accessories information

CONTROL PANEL

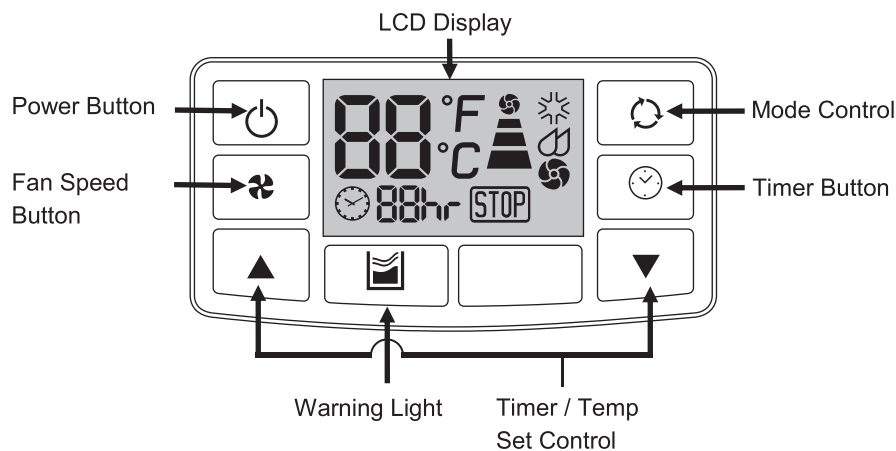

Indication symbols on LCD :

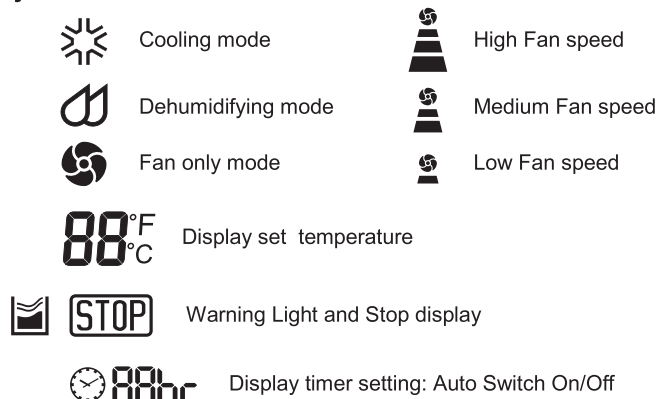

Power Button

Press to turn the air conditioner on and off

Mode Control

Press to change mode

- Controls the 3 function modes: COOL, FAN, and DEHUMIDIFY

Fan Speed Button

Press to change fan speed

- Controls the 3 fan speeds: HIGH, MEDIUM, and LOW. The fan speed indicator lights illuminates to show the set fan speed.

NOTE: Unit does not need to be vented in Fan Mode

Timer Button

Press to program Timer Delayed Switch ON or OFF function

Timer / Temp Set Control

Adjusts set temperature (1°C/ 1°F increments) or timer hours (0 – 24 hours).

- This unit is capable of displaying set temperature in Fahrenheit or in Celsius.
- To convert from one to the other, press and hold the Up and Down buttons for 3 seconds.

LCD Display

- In Cool mode: shows set temperature in °C or °F
- In DEHUMIDIFY and FAN only modes: shows room temperature.

Warning Light and Stop display

Condensed water may accumulate in the unit. If the internal tank becomes full, the Warning Light and STOP display will come on and the unit will not operate until the unit has been drained.

INSTALLATION

WARNING: NEVER OPERATE THE AIR CONDITIONER WITHOUT THE AIR FILTER

Your Whynter portable air conditioner is equipped with a washable Pre-Filter and an Activated Carbon Filter.

The washable Pre-Filter removes large particles such as dust, pet hair and dander.

The Activated Carbon filter is designed to remove smoke and other odors. It is recommended you replace the Activated Carbon filter every 2-3 months or as needed. Follow the steps below to install the filters.

1. Pull up the pre-filter frame (Fig. 1a)
2. Place the activated carbon filter on the pre-filter frame by inserting it through the three pins (Fig. 1b)
3. Once the activated carbon filter is secured, insert the assembled filter frame into the unit.

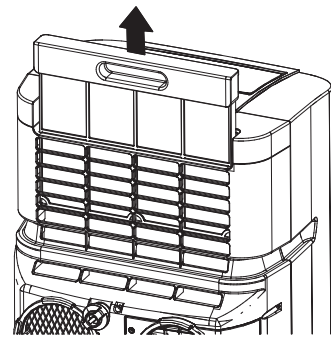

Fig. 1a

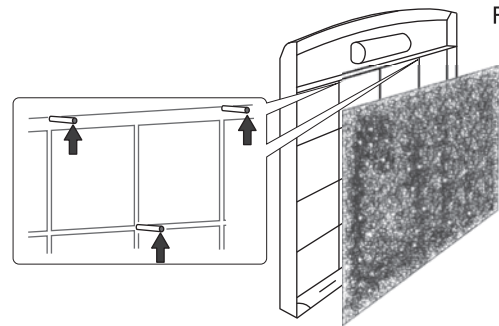

Fig. 1b

WATER DRAINAGE

The dehumidifying capacity of this unit is 82 pints per day. The patented self-evaporating function of the ARC-122DS unit fully exhausts all condensation automatically in most environments when humidity is less than 70%. Areas with more than 70% humidity, the self-evaporating function can still exhaust about 98% of the moisture and the remaining 2% of moisture will be collected in the water tank of the air conditioner.

When there is excess water condensation inside the unit, the air conditioner stops running and shows a warning light (refer to page 8). This warning light indicates that the water condensation needs to be drained using the following procedures:

• Manual drainage (Fig. 2a)

Turn off the unit. Carefully roll the unit to a drain location or position a flat container, dish or optional drain bucket accessory (sold separately) under the drain area of the lower drain port. Remove the drain cover and rubber plug and the condensed water will drain out automatically. Once all the condensed water is drained, replace the drain rubber plug and cover into the drain firmly.

• Continuous Gravity Drainage Option (Fig. 2b)

This option is recommended if uninterrupted operation is desired.

Remove the upper drain plug from the back of the unit and install the drain hose (sold separately). Place the open end of the hose to a drain area. This method is recommended if uninterrupted operation is desired.

WARNING: The hose must be directed downward from the upper drain port to allow the condensed water to flow with gravity.

Fig. 2a

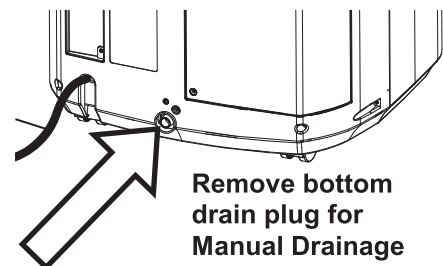
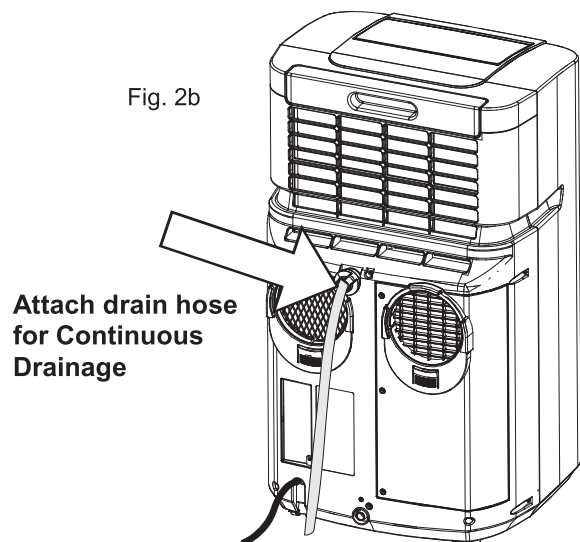

Fig. 2b



Note: Please contact support@whynter.com for retail sales information or visit whynter.com for a list of optional accessories.

INSTALLATION

Location

The air conditioner should be placed on a hard and level surface strong enough to support its weight. The unit is equipped with caster wheels for portability. It should only be rolled on smooth, flat surfaces. Use caution when rolling on carpet surfaces. Do not attempt to roll the unit over objects.

The air inlet and outlet should be free of any obstructions and be placed with at least 20" of clearance for efficient air-conditioning and circulation.

Exhaust hose Installation

When using the air conditioner, the hot air from the exhaust hose must be exhausted out of the room to complete the air exchange of the condenser. The intake hose is optional. When the unit is operating in dehumidifying or fan-only mode, installation of the exhaust hose is optional.

1. Expand each end of the exhaust (large) and intake (small) hoses about 6".
2. Install the Large Exhaust Slide Locking Hose Connector to one end of the exhaust hose (large hose) and the Large Exhaust Hose Connector with tab cut-outs to the other end of the exhaust hose (large hose) by turning counterclockwise.
3. Install the Small Intake Slide Locking Hose Connector to one end of the intake hose (small hose) and the Small Intake Hose Connector with tab cut-outs to the other end of the intake hose (small hose) by turning clockwise.
4. Install the larger exhaust hose (with connector attached). When facing the hose ports on the back of the unit, position the exhaust hose connector under the left side port (larger port) and face the larger end of the connector upside down, and slide up until the connector locks into place. Then, install the smaller intake hose (with connector attached). When facing the hose ports on the back of the unit, position the intake hose connector under the right side port (smaller port), and face the larger end of the connector upside down and slide up until the connector locks into place.

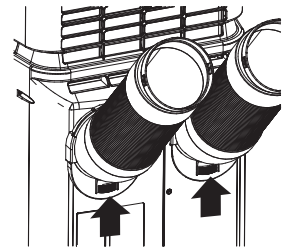

Only extend the hose to the necessary length, keeping it as short and as straight as possible. We do not recommend extending the hose more than 9' long. If you are interested in purchasing an additional 5' exhaust hose, please contact support@whynter.com for retail sales information or visit www.whynter.com for a list of optional accessories. Note: To remove the hose(s) from the unit, press the release button and slide the hose and connector out.

Window kit Installation

Your window kit has been designed to fit most standard vertical and horizontal windows. However, it may be necessary for you to modify the installation procedures for your window.

NOTE:

If your window opening is smaller than the minimum length of the window slider kit, the window slider kit can be cut to fit the window opening. Never cut into the exhaust and intake hose cut-outs on the window slider kit.

If your window opening is larger than the maximum length of the window slider kit, additional material will be needed to cover the open space such as, Plexiglas, PVC plastic, ply wood, etc. Alternately, an additional window slider kit can be purchased to be used in combination with the included kit.

When using the window slider kit on a window or sliding door, additional security measures may be needed.

1. Open the window approximately 5".
2. Adjust the length of the window slider to the same length or width of the opening of the window. Cut the window slider if necessary to fit the length of your window.
3. Insert the fixture through the back grooved side of the window slider hose-cutout, aligning the screw holes on the fixture with the screw holes on the unit. Place the screws in the holes from the front of the window slider kit and tighten. (Fig. 1)
4. Adjust the slider kit to fit your window. The slider kit comes with screws installed on the main window piece. The long and short extension pieces can be adjusted to fit your window, and the screws can be tightened to keep the extension pieces from sliding. Additional holes can be drilled in the window kit to allow for a further range of adjustment.
5. Fit the window slider kit into the window opening and close the window to secure the window slider kit. For long term installation, you may screw the window kit into your window frame.
6. Move the air conditioner close to the window, extend the hoses to the necessary length, keeping them as short and as straight as possible and attach the other end of each hose to the window slider kit.
7. Align the tab cut-outs of the hose connectors to the tabs on the fixtures and snap the hose connectors to the window slider kit.

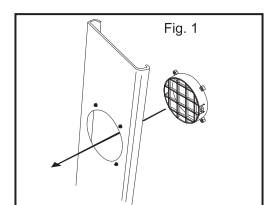
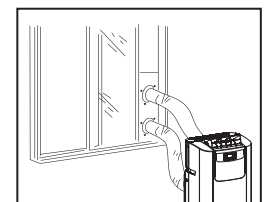
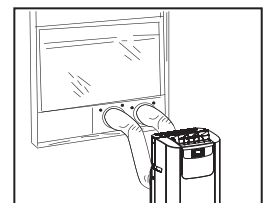

OPERATION INSTRUCTIONS

BEFORE USING YOUR APPLIANCE

- Remove the exterior and interior packaging
- Before connecting the appliance to a power source and operating, let the unit stand upright for a minimum of 4 hours. This will reduce the possibility of a malfunction in the cooling system from handling during transportation.

SWITCHING ON/OFF THE AIR CONDITIONER

The appliance can be switched ON or OFF by pressing the POWER button on the control panel or the ON/OFF button on the remote control

COOLING MODE

In this mode, the air conditioner cools and dehumidifies the room. To activate this function mode, press the Mode Control until the Cooling  indicator light comes on. When the cooling mode is set, the compressor will start in approximately 3 minutes. In cooling mode, hot air is exhausted from the outdoor exhaust port and the exhaust hose must be connected to exhaust out the hot air.

The temperature setting range of this air conditioner is from 61°F / 16°C to 89°F / 32°C. To set the temperature, press the ▲ or ▼ buttons. This air conditioner has a 5°F temperature cushion which if the set temperature is within 5°F of the ambient temperature, the unit runs on fan only mode. This saves energy and prolongs the life of the compressor of the air conditioner.

To set the fan speed, press the FAN button. In cooling mode, the difference in noise level between the 3 fan speeds is not very noticeable when the compressor is on. Try setting the unit to Fan only mode, you should be able to hear the difference between high and low fan speed settings.

A dual hose portable air conditioner will cool a room faster and will help minimize negative air pressure situation in the room. If the outside temperature is much higher or more humid than the room, the intake hose can be covered with the included cover and it will function like a single hose unit.

DEHUMIDIFYING ONLY MODE

In this mode, the air conditioner only dehumidifies the room, the compressor will activate intermittently depending on the ambient temperature and the fan speed is set to LOW. To activate this function mode, press the Mode Control until the Dehumidifying  indicator light comes on. Please note that when switching function mode, there will be an approximately 3 minute transition time. In dehumidifying mode, the hoses do require venting. If the hoses are vented, the room will be cooled as it dehumidifies and outside air will enter the unit. To prevent cooling and air intake, remove the hoses from the window kit and allow the warm air from the rear to be recirculated into the room. If room temperature is higher than 77°F, the fan speed can be adjusted. If room temperature is lower than 77°F, the fan speed is set at Low.

NOTE: When using dehumidifying mode, venting the exhaust hose to the outside is not required. If vented, the warm air is exhausted to the outside and cooling within the room may occur. Additionally, if the exhaust hose is not vented, the unit may require more frequent draining. The air conditioner does not have a humidistat in which a specific humidity level can be set.

FAN ONLY MODE

In this mode, only the fan of the air conditioner runs and circulates the air in the room. To activate this function mode, press the MODE button until the Fan  indicator light comes on. In this function mode, the temperature cannot be set. Subsequently, set the desired fan speed by pressing the Fan button. Fan Only mode does not require the use of both exhaust and intake hoses.

OPERATION INSTRUCTIONS

TIMER (DELAYED SWITCH ON / OFF) FUNCTION

This function mode enables a delayed switch ON or delayed switch OFF of the air conditioner. The time (hours) delay can be set, enabled and disabled. The timer is adjustable between 1 - 24 hours.

SETTING SWITCH OFF TIMER

With the air conditioner operating in any function mode, press the Timer button. The display timer setting will come on. Set the desired time delay OFF hours by pressing the▲and▼buttons. The time increments are at 1 hour to up to 24 hours. When the delay time set has elapsed, the air conditioner switches off. To cancel the delayed switch off function, press the Timer button or turn off the air conditioner.

SETTING DELAYED SWITCH ON TIMER

With the air conditioner is off, press the Timer button. The display timer setting will come on. Set the desired time delay ON hours by pressing the▲and▼buttons. The time increments are at 1 hour to up to 24 hours. When the delay time set has elapsed, the air conditioner switches on. To cancel the delayed switch on function, press the Timer button or turn on the air conditioner.

AUTO RESTART

In the event of a power outage, the air conditioner restarts at the previously set function mode and settings when power is restored.

NOISE LEVEL

Portable air conditioners may make sounds that are not familiar to you. The sounds listed below are normal. Noise reflecting off hard surfaces such as a floor or wall can make the sounds seem louder than they actually are.

- The compressor may make a pulsating or high-pitched sound
- Water running from the evaporator to the water tank may make a splashing sound
- Refrigerant flowing may make a gurgling sound
- Fan sound may come from front and back air vents

COMPRESSOR LOCK OUT

This portable air conditioner is optimized to operate in an ambient temperature of 64°F – 95°F. The compressor circuit has an automatic 3 minute time delayed start if the unit is turned off and on quickly. This prevents over-heating of the compressor and possible circuit breaker tripping.

REMOTE CONTROL

The portable air conditioner can be switched on by the remote control. To transmit signals from the remote control to the air conditioner, point the front part of the remote handset towards the control panel on the air conditioner. Reception of the signal is confirmed by a beep. The maximum signal transmission distance is approximately 8 meters / 26 feet.

NOTE:

- Other appliances in the same room controlled by a remote control (TV, radio, stereo, etc.), may cause interferences
- Electronic and fluorescent lamps may interfere with the signal transmissions between the remote control and the air conditioner
- Remove the batteries if the remote control is not used for long periods

INSTALLING BATTERIES

To insert the batteries, open the flap on the back of the remote control by sliding it off. Strictly adhere to the polarity signs on the bottom of the battery housing, close the flap once the batteries have been inserted.

- Only use two dry LR03 AAA 1.5V Batteries (included) in the remote control
- Always change both batteries at the same time

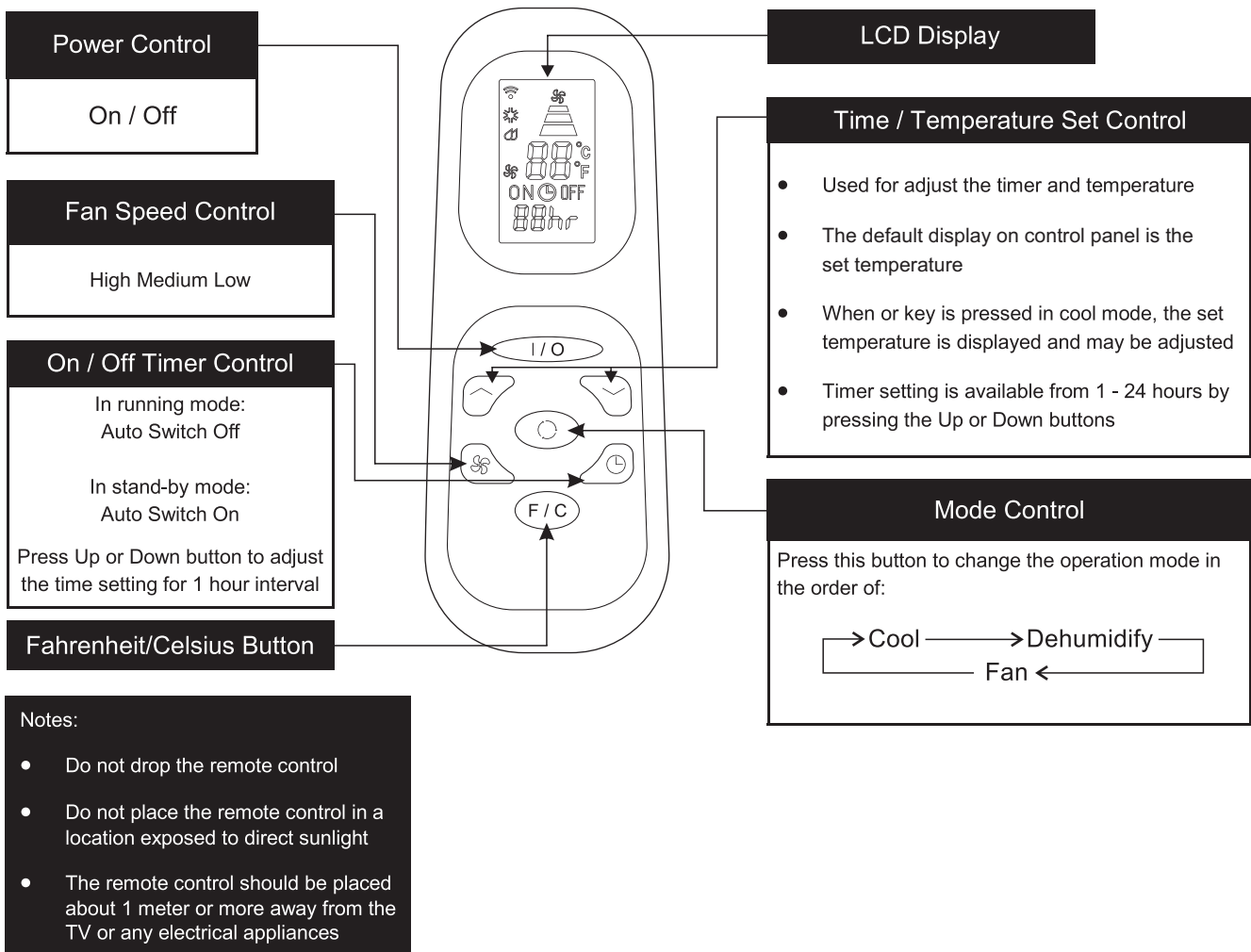
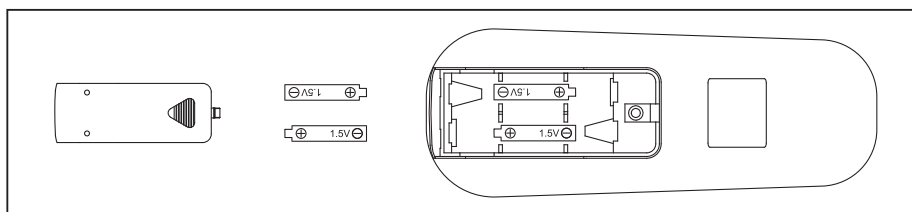

CARE AND MAINTENANCE

IMPORTANT:

- Switch off the air conditioner and disconnect the plug from the power outlet
- Drain water by removing the drain plug
- Always transport the air conditioner in an upright position only

CLEANING THE AIR FILTERS

- To ensure the air intake is filtered properly and to assure that your air conditioner runs efficiently, it is recommended to clean the air filters at least once every two weeks
- This unit has two air filters; washable pre-filter and an activated carbon filter.
- Switch off the air conditioner and remove the washable pre-filter and an activated carbon filter
- Use a vacuum cleaner or tap lightly to remove loose dust and dirt from the pre-filter. Then rinse them thoroughly under warm or cold running water (no hotter than 100°F.)
- Dry thoroughly before re-inserting the filters.
- *NOTE: The activated carbon filter is not washable. It should be replaced every 2-3 months or as needed. Please contact support@whynter.com for retail sales information*

WARNING! Never operate the air conditioner without the filter in place

CLEANING THE AIR CONDITIONER

- Always switch off the air conditioner and disconnect the plug from the power supply outlet before cleaning the air conditioner
- Use a soft damp cloth to wipe the body of the unit.
- Never use harsh chemicals, oil-based products, detergents, chemically treated cloths or other cleaning solutions. These could possibly damage the body of the air conditioner

END OF SEASON STORAGE

This portable air conditioner comes with one end of season storage cover. We highly recommend that storage cover bag is utilized when the unit is not going to be used for a period of time.

WARNING: To avoid danger of suffocation, keep this bag away from babies and children.

- Switch off the air conditioner and disconnect the power plug from the power supply outlet before cleaning the air conditioner
- Clean the air filters
- Drain the condensed water completely
- Wrapped the power cord and bundle it with the tape.
- On a warm day, turn on the Fan only mode for half a day so that the inside can dry out completely
- Remove the batteries from the remote controller
- If leaving the window kit in place, disconnect the exhaust and intake hose from the window slider kit and place the included covers on the fixtures. To remove the hose connectors from the fixtures on the window kit, slightly turn, push and gently pull the connector to release. Otherwise, remove the window kit from the window opening.
- Place the storage cover over the air conditioner.

NOTE:

Please contact Whynter at support@whynter.com for additional internal maintenance cleaning instructions.

TROUBLESHOOTING

Many common portable air conditioner problems are easily resolved. Try the troubleshooting suggestions below to see if the problems can be resolved before having to contact the service department.

Problem	Possible Causes	Solutions
The portable air conditioner does not turn on	<ul style="list-style-type: none"> • Power failure / outage • The automatic switch, line fuse, or breaker has been tripped • The power supply voltage is too low • The power cord is damaged • The L.C.D.I. power plug for the unit is tripped • The internal water reservoir is full 	<ul style="list-style-type: none"> • Restore the power supply • Flip the switch / change the fuse / turn the breaker back on. Also note that you may have too many appliances drawing power on one circuit, you may need to move the other appliances to another circuit • Move the unit onto another circuit with the correct voltage • Call for service. Only authorized personnel should replace damaged power cord or power plug • Press the Reset button on the L.C.D.I. power plug • Drain water from the air conditioner • Possible loose internal connection. Please contact Whynter for service
The unit turns on but the compressor does not turn on (the fan runs but the unit is not cooling)	<ul style="list-style-type: none"> • The room temperature is outside of the operational tolerances of the unit • The Cooling mode is not on • The compressor has not turned on yet because of its time delay • The set temperature is too high • The internal water reservoir is full and Warning Light appears on display 	<ul style="list-style-type: none"> • This unit is designed to work in ambient temperatures of 64°F to 95°F • Press Mode Control until the Cooling indicator light is shown on the display • Give the compressor 3 minutes to turn on after the Cooling mode has been selected • Set the air conditioner to a lower temperature. It is recommended to set the temperature to at least 5°F of the ambient temperature • Either manually drain the water by removing the drain plug or allow the unit to exhaust the water itself by running the fan only mode. Then cooling will resume • Possible loose internal connection. Please contact Whynter for service
The air coming out of the unit is not very cold, or the airflow volume is weak	<ul style="list-style-type: none"> • The filters are dirty or obstructed • The air intake or exhaust is obstructed • The unit is set in DEHUMIDIFY or FAN mode • The unit is set to low fan speed 	<ul style="list-style-type: none"> • Clean the air filters • Make sure there is at least 20" of clearance from the air intake. Make the length of the exhaust hose is as short as possible • Set the unit to Cooling mode • Set the unit to a higher fan speed

TROUBLESHOOTING

Problem	Possible Causes	Solutions
The unit has worked for a long time, but the room is not cold enough	<ul style="list-style-type: none"> • Windows or doors are open • There are too many people in the room • There is direct sunshine into the room • The room is a kitchen or with many heat-producing appliances • There is a server in the room • The room is too large 	<ul style="list-style-type: none"> • Close all windows and doors • You may need additional cooling or another air conditioner • Close curtains or blinds and try to minimize the amount of direct sunlight into the room • You may need additional cooling or another air conditioner
The unit is very noisy	<ul style="list-style-type: none"> • The unit is not level • The surface underneath the unit is uneven • Low power voltage 	<ul style="list-style-type: none"> • Make sure the unit is on hard, level and stable surface • Move the unit to a location with a level and hard floor • Make sure the wall outlet and support the required power consumption of the air conditioner and do not use an extension cord
The unit leaks water	<ul style="list-style-type: none"> • The unit is tilted or not leveled • The water tank is full 	<ul style="list-style-type: none"> • Make use the unit is leveled • Drain water from the drain plug at the back of the air conditioner
Fan speed cannot be changed	<ul style="list-style-type: none"> • Fan speed differences are not very noticeable 	<ul style="list-style-type: none"> • The fan speed difference is not very noticeable when the compressor is on. Try setting the unit to Fan only mode, you should be able to hear the difference between high and low fan speed settings.

ADDITIONAL TIPS

1. Keep the exhaust hose as short and straight as possible

The exhaust hose removes heat from the room. It should remain as short and straight as possible without sharp bends or twists to maximize efficiency. If the exhaust hose must be extended, do not exceed 9'.

2. Turn the air conditioner on early

Turning the air conditioner on early instead of waiting until the hottest point of the day will allow the unit to be more effective. The air conditioner will not have to work as hard to cool the room down and maintain the set temperature.

3. Reduce heat sources

Direct sunlight, televisions, computers and other heat generating appliances work against the air conditioner by introducing heat into the space.

- Close window curtains and blinds to keep direct sunlight out
- Close doors and windows
- Keep ovens and stoves off
- Turn off unused lights
- Add weather stripping around windows and doors

4. Keep the air filter clean

Regular cleaning will help keep your air conditioner working properly. Dusty filters and vents greatly reduce the airflow and efficiency of the unit.

- Clean the washable pre-filter regularly
- Replace the activated carbon filter every 2-3 months depending on use
- Vacuum any accumulated dust from around all vents

5. Remove the intake hose

Remove the intake hose to prevent the unit from over-working when the outdoor humidity or temperature is high.

ONE YEAR LIMITED WARRANTY & THREE YEAR WARRANTY ON COMPRESSOR

This WHYNTER product is warranted to the original owner, purchased from an authorized Whynter dealer within the 48 U.S. continental states, for one year from the original purchase date against defects in material and workmanship under normal residential usage. Should your WHYNTER product prove defective within one year from the date of purchase, contact Whynter's Customer Support team with the serial number and proof of purchase to make a warranty claim. A Return Authorization number must be issued before returning any parts or products. Parts or products received without a Whynter issued Return Authorization number will be refused. Under this warranty, Whynter will repair or replace any parts found defective with new or remanufactured parts or exchange the defective product with a new, refurbished, or remanufactured product at our discretion. All defective products and parts covered by this warranty will be repaired or replaced on a mail-in basis to Whynter's Service Center. This warranty is not transferable. After the expiration of the warranty, the cost of labor and parts will be the responsibility of the original owner.

The compressor of portable air conditioners is warranted for an additional two years after the one year limited warranty expires from the date of purchase.

Return freight is prepaid by Whynter within two months of purchase. After two months to one year, the customer will be responsible for the return freight cost to Whynter's Service Center. Please package the product carefully in its original packaging to avoid damage in transit. Whynter is not responsible for damage resulting from shipper mishandling or improper packaging. Please retain the original box and packaging materials.

THIS WARRANTY DOES NOT COVER:

- Acts of God, such as fire, flood, hurricanes, earthquakes and tornadoes.
- Improper power supply such as power surge, low voltage, defective household wiring or inadequate fuses.
- Use in commercial or industrial applications.
- Damage, accidental or otherwise, to the product while in the possession of a consumer not caused by a defect in material or workmanship.
- Damage caused by consumer misuse, tampering, lack of maintenance or failure to follow the care and special handling provisions in the instructions.
- Damage to the finish of the case, or other appearance parts caused by wear.
- Damage caused by repairs or alterations to the product by anyone other than authorized by the manufacturer.
- Removal, Replacement Packaging, Freight and Insurance cost for the warranty service.
- Products sold AS IS or from an unauthorized reseller.
- Products that have had their serial numbers removed or defaced.

DISCLAIMER OF IMPLIED WARRANTIES; LIMITATION OF REMEDIES

CUSTOMER'S SOLE AND EXCLUSIVE REMEDY UNDER THIS LIMITED WARRANTY SHALL BE PRODUCT REPAIR OR REPLACEMENT AS PROVIDED HEREIN. CLAIMS BASED ON IMPLIED WARRANTIES, INCLUDING WARRANTIES OF MERCHANTABILITY OR FITNESS FOR A PARTICULAR PURPOSE, ARE LIMITED TO ONE YEAR OR THE SHORTEST PERIOD ALLOWED BY LAW, BUT NOT LESS THAN ONE YEAR. WHYNTER SHALL NOT BE LIABLE FOR CONSEQUENTIAL OR INCIDENTAL DAMAGES SUCH AS PROPERTY DAMAGE AND INCIDENTAL EXPENSES RESULTING FROM ANY BREACH OF THIS WRITTEN LIMITED WARRANTY OR ANY IMPLIED WARRANTY. SOME STATES AND PROVINCES DO NOT ALLOW THE EXCLUSION OR LIMITATION OF INCIDENTAL OR CONSEQUENTIAL DAMAGES, OR LIMITATIONS ON THE DURATION OF IMPLIED WARRANTIES, SO THESE LIMITATIONS OR EXCLUSIONS MAY NOT APPLY TO YOU. THIS WRITTEN WARRANTY GIVES YOU SPECIFIC LEGAL RIGHTS. YOU MAY ALSO HAVE OTHER RIGHTS THAT VARY FROM STATE TO STATE.

The warranty, product contents and specifications are subject to change at any time without notice; please refer to www.whynter.com for the most current information.

Please retain the original proof of purchase.

To register your warranty, please visit www.whynter.com and fill out the online Warranty Registration form. Please be sure to include a copy of your purchase invoice.

To obtain service or information, contact Whynter LLC via email at support@whynter.com or call 866-WHYNTER (866-949-6837).

Copyright © 2023 Whynter LLC
www.whynter.com