

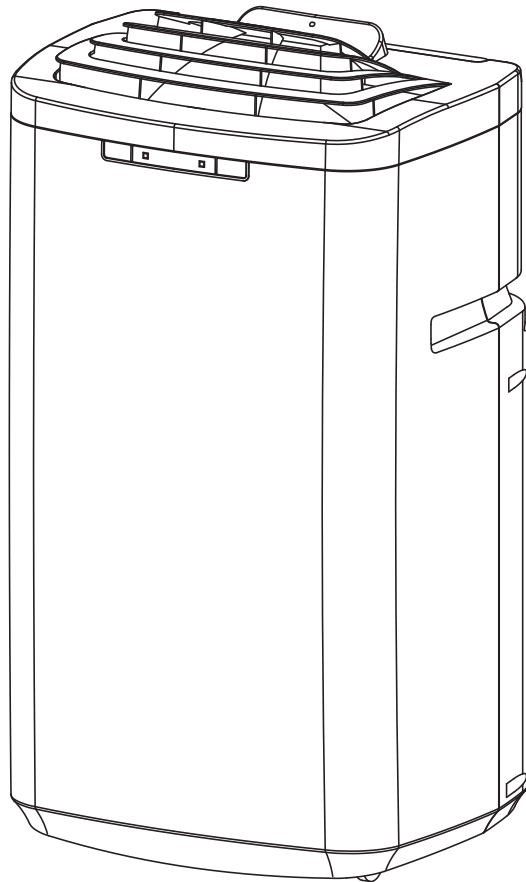

WHYNTER 13,000 BTU DUAL HOSE PORTABLE AIR CONDITIONER

MODEL# : ARC-131GD

Instruction Manual



Congratulations on your new WHYNTER product. To ensure proper operation, please read this Instruction Manual carefully before using this product. Keep this manual in a safe place for future reference.

TABLE OF CONTENTS

INTRODUCTION	3
SAFETY PRECAUTIONS	4-5
IDENTIFICATION OF ACCESSORIES	6
IDENTIFICATION OF PARTS	7
INSTALLATION INSTRUCTIONS	8-9
AIR FILTERS INSTALLATION	10
REMOTE CONTROL	11
OPERATION INSTRUCTIONS	11-14
WATER DRAINAGE	15
CARE AND MAINTENANCE	16
TECHNICAL DATA	17
TROUBLESHOOTING	18-19
WARRANTY INFORMATION	20

Thank you for choosing the Whynter portable air conditioner. Please follow the instructions provided in this user guide to obtain the very best performance from your portable air conditioner and take full advantage of the many features your portable air conditioner offers you. We trust that your Whynter air conditioner will provide the performance and reliability that we stand for.

Please keep this user manual in a safe place for future reference.

DISPOSAL

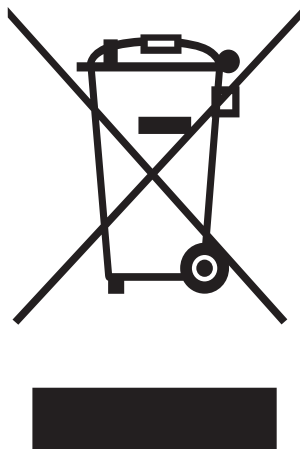

This symbol on the product or its packaging indicates that the appliance cannot be treated as normal domestic trash, but must be handed in at a collection point for recycling electric and electronic appliances. Your contribution to the correct disposal of this product protects the environment. Further information about the recycling of this product can be obtained from your local municipal authority.

Your safety and the safety of others are very important to us.

To reduce the risk of fire, electrical shock or injury when using your appliance, follow these basic precautions.

SAFETY PRECAUTIONS



Before the portable air conditioner is used, it must be properly positioned and installed as detailed in this manual.

DANGER

- Do not under any circumstances cut or remove the third (ground) prong from the power cord.
- Make sure this unit is connected to a correctly grounded power supply outlet. Do not use an extension cord or power strip.
- The power cord is UL listed. It has a built-in L.C.D.I. (leakage, current, detection, interruption) circuit breaker for added safety. If the power supply is interrupted, press the reset button to reconnect the unit to power source.
- It is recommended to use a separate circuit that its size should be 15 Amps for the air conditioner.
- Do not use an excessively wet cloth, industrial solvents, oil-based products to clean this portable air conditioner.
- To avoid the risk of shock, the product should never be used in bathrooms, shower rooms, or in any other steamy or wet areas.
- Do not store or use gasoline or other flammable vapors and liquids in the vicinity of this or any other appliances.
- Do not repair, disassemble and/or modify the unit by yourself.
- Always turn off the portable air conditioner when cleaning the air filter, and transporting.
- Do not turn this unit on and off by plugging and unplugging. Always use the ON/OFF switch.

WARNING

- Transport the unit in an upright position only, or leave it in an upright position for a minimum of 4 hours before first use.
- Ensure curtains or other objects are not obstructing the air inlet filters.
- Do not bend or crush the exhaust hose while in use.
- Always allow at least 20" of clearance around the unit for ventilation. Do not use this unit inside closets, cabinets and/or cramped spaces between furniture.
- This unit is optimized to operate in an ambient temperature of 64°F – 95°F.
- This unit must be installed in an area protected from the elements, such as wind, rain, water spray or drips.
- The unit should not be placed next to ovens, grills or other heat sources.
- Always place the unit on even and hard and level surface.
- Do not sit or place objects on the unit.
- Do not allow children to climb, stand or hang on the unit. The air conditioner could tip over and get damaged and/or seriously injure somebody.

- Keep fingers out of the air intakes and air outlets.
- The unit is an electrical appliance. To avoid injury from electrical shock do not operate it with wet hands, while standing on a wet surface or while standing in water. Do not use it in outdoors or in wet conditions.
- When positioning or moving the unit, ensure it is not turned upside down or greater than 45° or more off level.
- This unit is designed for household, non-commercial use only. Any other use will void the warranty.
- Do not plug into the power outlet before set up is completed.
- Do not operate this unit without the air filter(s).
- Do not use harsh chemicals to clean the filter(s). Dry thoroughly before inserting the filter(s) into the unit.
- Do not add extra length to the exhaust hose by more than a total length of 9'. This will reduce the cooling efficiency of the portable air conditioner.
- At the end of each season, all water must be drained from the unit and filter(s) must be cleaned before storage.

THE MANUFACTURER DISCLAIMS ANY RESPONSIBILITY IF THE ABOVE INSTRUCTIONS ARE NOT FOLLOWED.

OPERATING CONDITION



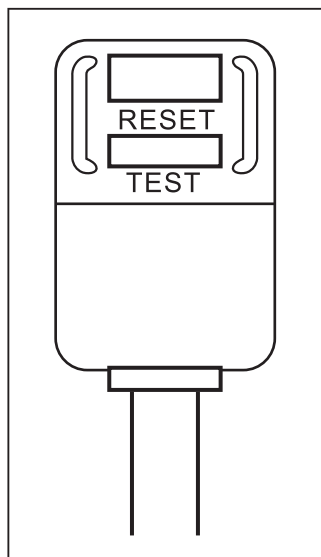







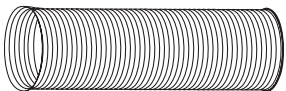
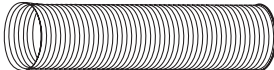

MODE	ROOM TEMPERATURE
COOL	Higher than 66°F
DRY	Higher than 60°F

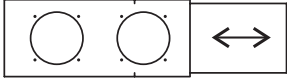

Your portable air conditioner is supplied with a Leakage-Current Detection and Interruption (LCDI) plug. This plug reduces the risk of fire due to arcing faults in the power supply cord. Please follow the instructions below to ensure that LCDI plug works properly.

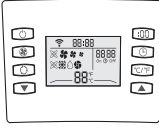
1. Plug the power cord to a grounded wall outlet. Do not plug to a power strip or extension cord.
2. Press the TEST button on the plug. This should trip the plug and cut the power to the air conditioner. If the plug does not trip and the unit comes on, please contact technical support.
3. Press the RESET button to start the air conditioner.
4. Do NOT use the TEST and RESET buttons to turn the air conditioner on and off.

IDENTIFICATION OF ACCESSORIES

IMAGE	ACCESSORY NAME	QUANTITY
	Exhaust hose (large)	1 piece
	Intake hose (small)	1 piece
	Fixtures ** attached to the covers upon unboxing **	2 pieces
	Screws	8 pieces
	1 Large Exhaust Hose Connector to Window Kit with tab cut-outs	1 piece
	1 Large Slide Locking Exhaust Hose Connector to unit	1 piece
	1 Small Slide Locking Intake Hose Connector to unit	1 piece
	1 Small Intake Hose Connector to Window Kit with tab cut-outs	1 piece
	Window slider kit	1 set
	Covers ** attached to the fixtures upon unboxing **	2 pieces
	Remote control	1 piece
	Storage Cover	1 piece
	Carbon Filter	1 piece
	Optional Intake filter (sold separately)	1 piece

- ** The fixture pieces may come attached to the cover pieces. To remove, twist the cover pieces to allow the tab from the fixtures to disengage from the covers, and twist the covers to remove from the fixtures.

IDENTIFICATION OF PARTS

Front

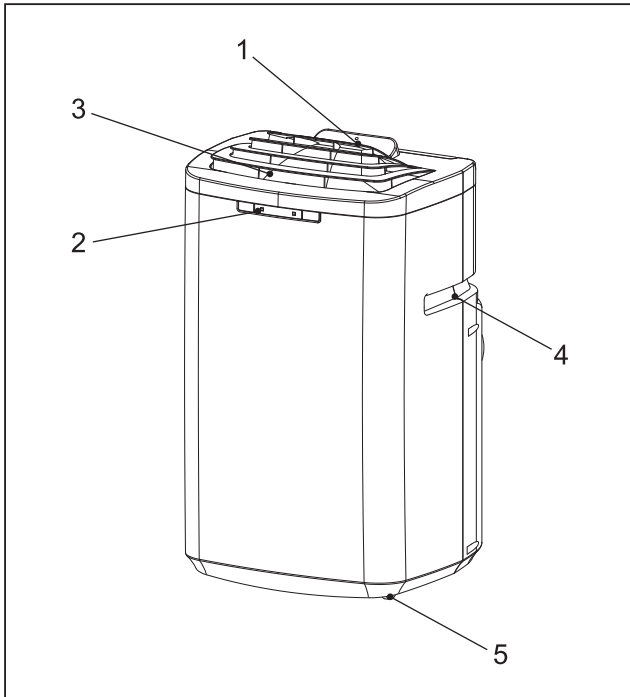

1. Remote control
2. Front display
3. Air outlet
4. Handle
5. Wheels

Rear

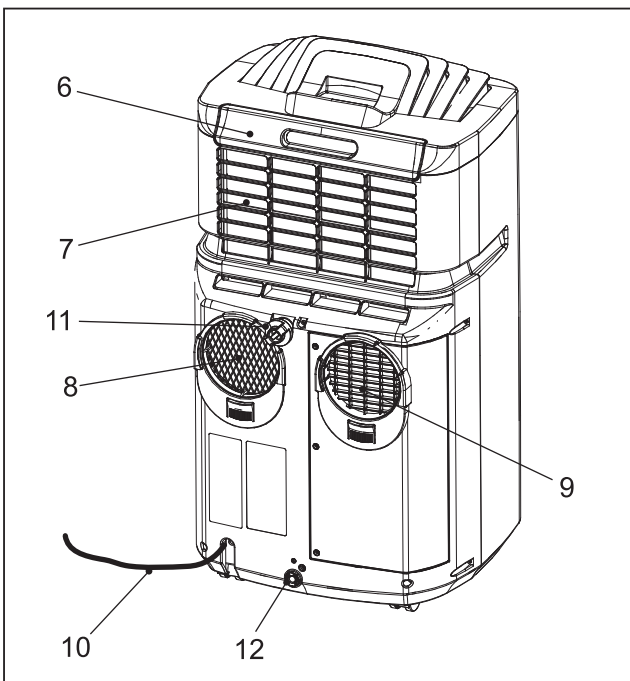

6. Air filter
7. Air intake (evaporator)
8. Air exhaust - large hose
9. Air intake (condenser) - small hose
10. Power cord
11. Upper drain port (rubber plug and cover)
12. Lower drain port (rubber plug and cover)

INSTALLATION INSTRUCTIONS

Location

The air conditioner should be placed on a hard and level surface strong enough to support its weight. The unit is equipped with caster wheels for portability. It should only be rolled on smooth, flat surfaces. Use caution when rolling on carpet surfaces. Do not attempt to roll the unit over objects.

The air inlet and outlet should be free of any obstructions and be placed with at least 20" of clearance for efficient air-conditioning and circulation.

Exhaust hose Installation

When using the air conditioner, the hot air from the exhaust hose must be exhausted out of the room to complete the air exchange of the condenser. The intake hose is optional. When the unit is operating in dehumidifying or fan-only mode, installation of the exhaust hose is optional.

1. Expand each end of the exhaust (large) and intake (small) hoses about 6".
2. Install the Large Exhaust Slide Locking Hose Connector to one end of the exhaust hose (large hose) and the Large Exhaust Hose Connector with tab cut-outs to the other end of the exhaust hose (large hose) by turning counterclockwise.
3. Install the Small Intake Slide Locking Hose Connector to one end of the intake hose (small hose) and the Small Intake Hose Connector with tab cut-outs to the other end of the intake hose (small hose) by turning clockwise.
4. Install the larger exhaust hose (with connector attached). When facing the hose ports on the back of the unit, position the exhaust hose connector under the port and face the larger end of the connector upside down, and slide up until the connector locks into place. Then, install the smaller intake hose (with connector attached). When facing the hose ports on the back of the unit, position the intake hose connector under the right side port (smaller port), and face the larger end of the connector upside down and slide up until the connector locks into place.

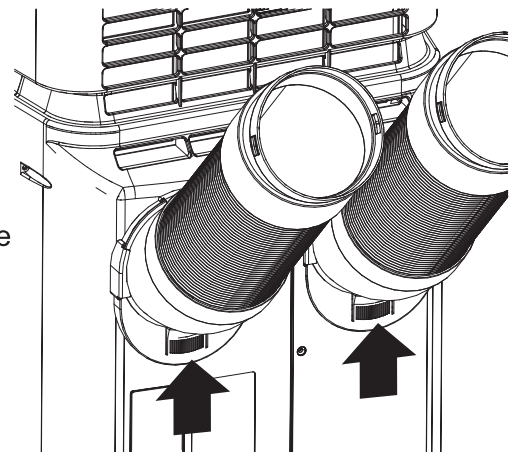

Only extend the hose to the necessary length, keeping it as short and as straight as possible. We do not recommend extending the hose more than 9' long. If you are interested in purchasing an additional 5' exhaust hose, please contact support@whynter.com for retail sales information or visit whynter.com for a list of optional accessories.

Note: To remove the hose(s) from the unit, press the release button and slide the hose and connector out.

Window kit Installation

Your window kit has been designed to fit most standard vertical and horizontal windows. However, it may be necessary for you to modify the installation procedures for your window.

NOTE:

If your window opening is smaller than the minimum length of the window slider kit, the window slider kit can be cut to fit the window opening. Never cut into the exhaust and intake hose cut-outs on the window slider kit.

If your window opening is larger than the maximum length of the window slider kit, additional material will be needed to cover the open space such as, Plexiglas, PVC plastic, plywood, etc. Alternately, an additional window slider kit can be purchased to be used in combination with the included kit.

When using the window slider kit on a window or sliding door, additional security measures may be needed.

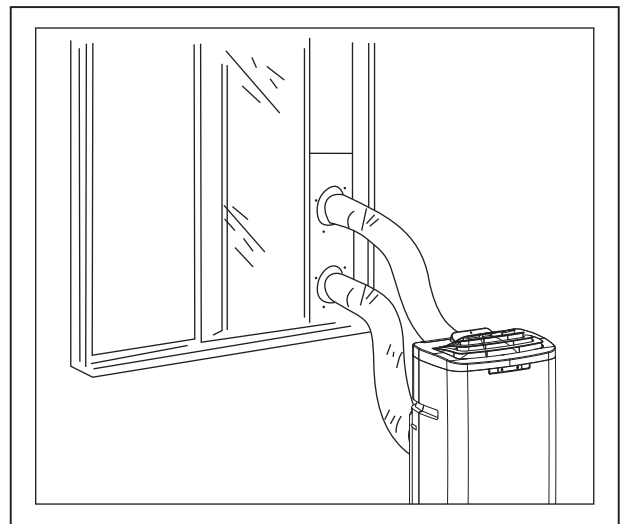
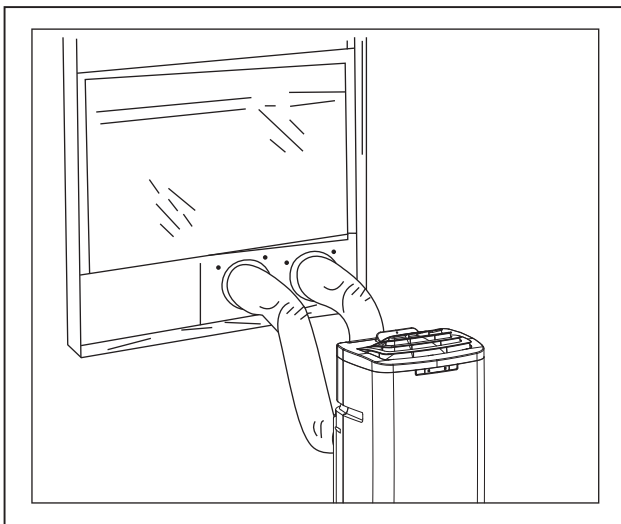

1. Open the window approximately 5”.
2. Adjust the length of the window slider to the same length or width of the opening of the window. Cut the window slider if necessary to fit the length of your window.
3. Insert the fixture through the back grooved side of the window slider hose-cutout, aligning the screw holes on the fixture with the screw holes on the unit. Place the screws in the holes from the front of the window slider kit and tighten. (Fig. 1)
4. Adjust the slider kit to fit your window. The slider kit comes with screws installed on the main window piece. The long and short extension pieces can be adjusted to fit your window, and the screws can be tightened to keep the extension pieces from sliding. Additional holes can be drilled in the window kit to allow for a further range of adjustment.
5. Fit the window slider kit into the window opening and close the window to secure the window slider kit. For long term installation, you may screw the window kit into your window frame.
6. Move the air conditioner close to the window, extend the hoses to the necessary length, keeping them as short and as straight as possible and attach the other end of each hose to the window slider kit.
7. Align the tab cut-outs of the hose connectors to the tabs on the fixtures and snap the hose connectors to the window slider kit.

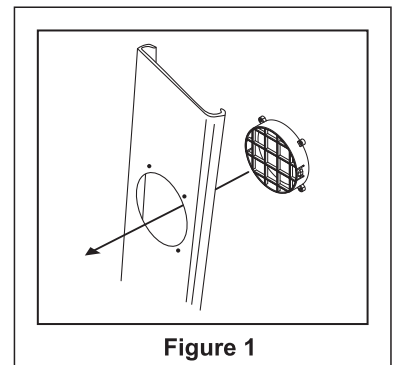

AIR FILTERS INSTALLATION

Your Whynter portable air conditioner is equipped with a washable Pre-Filter and an activated carbon filter.

The washable Pre-Filter removes large particles such as dust, pet hair and dander.

The activated carbon filter is designed to remove smoke and other odor. It is recommended to replace the activated carbon filter every 2-3 months. Follow the steps below to install the filters.

WARNING: NEVER OPERATE THE AIR CONDITIONER WITHOUT THE PRE-FILTER

1. Pull up the pre-filter frame and remove from the unit.

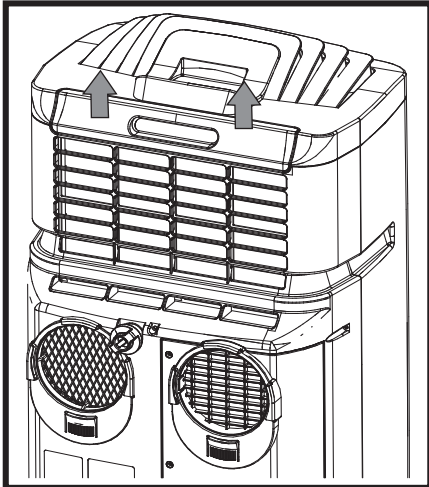

2. Place the activated carbon filter on the pre-filter frame by inserting it through the three pins.

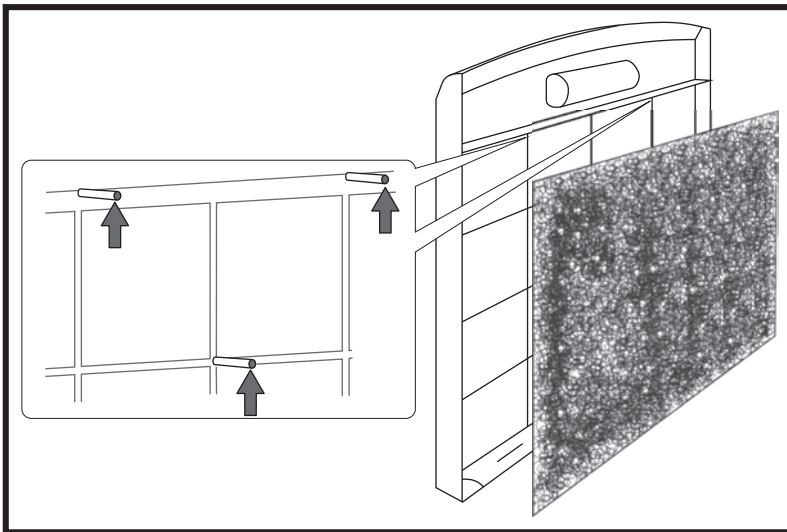

3. Once the activated carbon filter is secured, insert the assembled filter frame into the unit.

OPERATION INSTRUCTIONS





Before you begin, thoroughly familiarize yourself with the control panel of the remote control. Follow the symbol for the desired function. The functions of the unit can be controlled by the remote control only. When using the remote control, make sure the reception of the signal is confirmed by a beep.

NOTE:

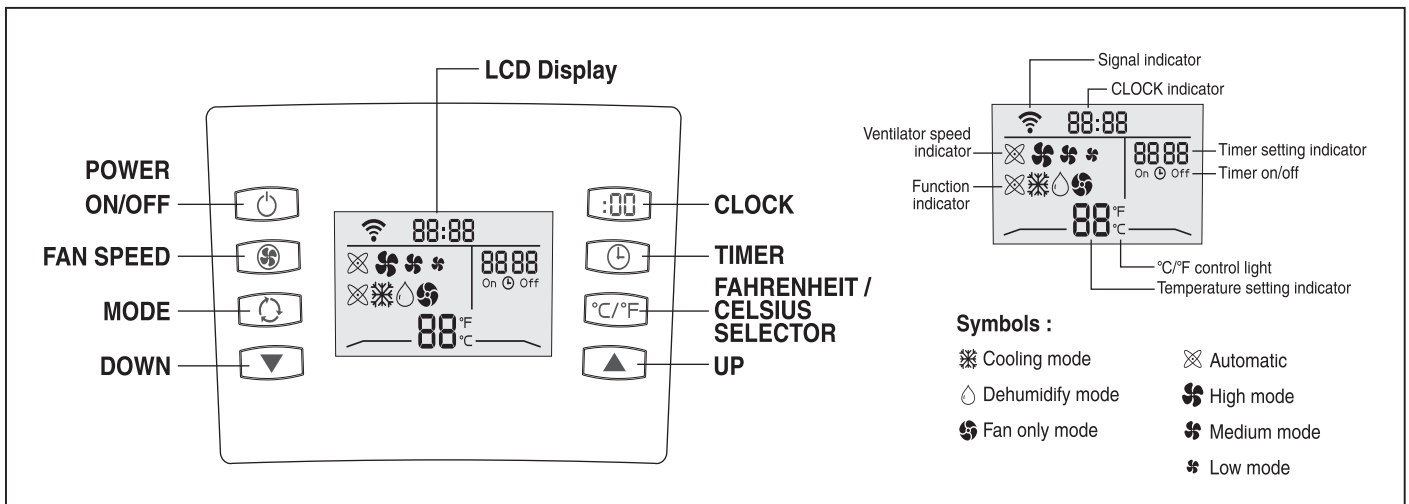
- Other appliances in the same room controlled by a remote control (TV, radio, stereo, etc.), may cause interferences.
- Electronic and fluorescent lamps may interfere with the signal transmissions between the remote control and the air conditioner.
- Remove the batteries if the remote control is not used for long periods.

REMOTE CONTROL PANEL



<p>Power Control </p> <p>Turns the unit on and off.</p>	<p>Timer / Temperature Set Control</p> <p>The set temperature can be set between 61°F (16 °C) and 89°F (32°C) by pressing the ▲ and ▼ buttons in cooling mode only.</p>
<p>Fan Speed Control </p> <p>Controls the 4 fan speeds: Auto, High, Medium & Low. NOTE: Unit does not need to be vented in Fan mode.</p>	<p>Clock </p> <p>Sets the current time.</p>
<p>Mode Control </p> <p>Controls the 4 function modes: COOL ❄️, DEHUMIDIFY 💧, FAN ONLY 🌀 and AUTOMATIC ⊗.</p>	<p>Timer </p> <p>Turns the timer function on and off.</p>
	<p>Fahrenheit / Celsius Selector °C/°F</p> <p>Changes the display temperature from Fahrenheit to Celsius and vice versa.</p>

FRONT PANEL

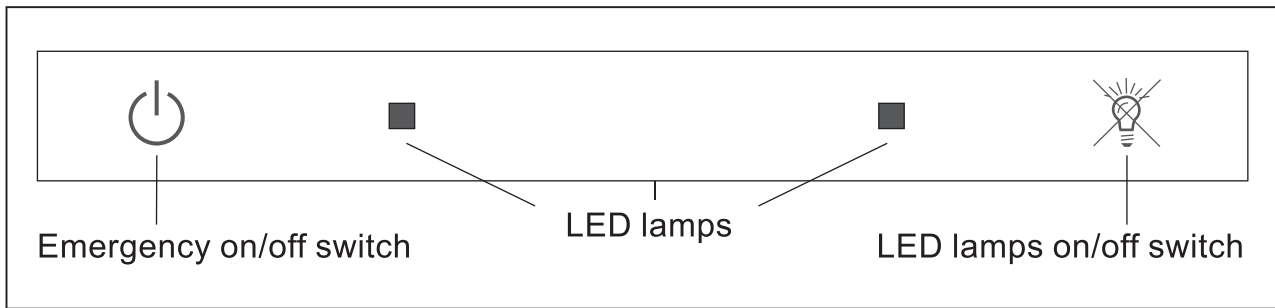

SWITCHING ON/OFF THE AIR CONDITIONER

- The unit can be switched ON or OFF by pressing the Emergency on/off switch button  on the front display panel or the remote control.
NOTE: The functions of the portable air conditioner can be switched on by the remote control ONLY. Without using the remote control, the unit can only be switched on at the previous setting and turn off the unit.

LED LAMPS ON/OFF SWITCH

- Press the LED lamps on/off switch to turn on and off the LED lamps indicators.



WARNING LIGHT

- When the internal water reservoir is full, the red light will flash and the unit will stop. Remove the drain plug to drain out the water and the unit will restart at the previous setting.

➤ BEFORE USING YOUR PORTABLE AIR CONDITIONER

- Remove the exterior and interior packaging.
- Before connecting the unit to the power source, let it stand upright for approximately 4 hours. This will reduce the possibility of a malfunction in the cooling system from handling during transportation.

COOLING MODE

- In this mode, the air conditioner cools and dehumidifies the room. To activate this function mode, press the Mode Control button until the  indicator comes on. When the cooling mode is set, the blue light on the front panel comes on and the compressor will start in approximately 3 minutes.
NOTE: In cooling mode, hot air is exhausted from the outdoor exhaust port and the exhaust hose must be connected to exhaust out the hot air.
- The temperature setting range of this air conditioner is from 61°F to 89°F. To set the temperature, press the  or  buttons. The air conditioner has a 5° F temperature cushion; if the set temperature is within 5° F of the ambient temperature, the fan will switch to low speed and run approximately 5 minutes before it shuts off. The fan will activate again in approximately 15 minutes and run for 1 minute to circulate air in the room and detect the ambient room temperature. If the room temperature is higher than 5° F of the set temperature, the compressor will turn on and the fan will run in the set speed.
- To set the fan speed, press the Fan Speed button. **In cooling mode, the difference in noise level between the fan speeds is not very noticeable when the compressor is on.** Try setting the unit to Fan only mode, you should be able to hear the difference between high and low fan speed settings.

DEHUMIDIFYING MODE

- In this mode, the air conditioner only dehumidifies the room, the compressor will activate intermittently depending on the ambient temperature. To activate this function mode, press the Mode Control button until the  indicator comes on. When the dehumidifying mode is set, the orange light on the front panel comes on.
- Please note that when switching function mode, there will be an approximately 3 minute transition time. In dehumidifying mode, the exhaust hose does not need to be vented. If the exhaust hose is vented, the room will be cooled as it dehumidifies. To prevent cooling, remove the exhaust hose from the window kit and allow the warm air from the rear to be recirculated into the room. If room temperature is higher than 77°F, the fan speed can be adjusted. If room temperature is lower than 77°F, the fan speed is set at Low.

NOTE: When using dehumidifying mode, venting the exhaust hose to the outside is not required. If vented, the warm air is exhausted to the outside and cooling within the room may occur. Additionally, if the exhaust hose is not vented, the unit may require more frequent draining. The air conditioner does not have a humidistat in which a specific humidity level can be set.

FAN ONLY MODE

- In this mode, only the fan of the air conditioner runs and circulates the air in the room. To activate this function mode, press the Mode Control button until the  indicator comes on. When the fan only mode is set, the green light on the front panel comes on.
- In this function mode, the temperature cannot be set. Subsequently, set the desired fan speed by pressing the Fan Speed button. Fan Only mode requires that the exhaust hose be removed.

NOTE: The unit does not require venting in Fan Only mode.

AUTOMATIC MODE



- When you set the air conditioner in AUTOMATIC mode, it will automatically select cooling or fan only operation to 85F depending on the ambient temperature. The fan speed is automatically selected and cannot be changed and the temperature cannot be set.
- To activate this function mode, press the Mode Control button until the  indicator comes on. When the automatic mode is set, the light on the front panel displays the color of the mode that the unit is currently operating in.

NOTE: In Automatic mode, hot air is exhausted from the outdoor exhaust port and the exhaust hose must be connected to exhaust out the hot air.

FAN SPEED CONTROL

- To set the fan speed, press the fan speed control  button. Fan speed can be set at Automatic, High, Medium and Low.



CLOCK

- To set the clock, press and hold the clock button  for 3 seconds. Press the up or down buttons to set the current time. To save the current time, press and hold the clock button  again for 3 seconds.

TIMER (DELAYED SWITCH ON / OFF) FUNCTION



- This function mode enables a delayed switch ON or delayed switch OFF of the air conditioner. The time (hours) delay can be set, enabled and disabled. The timer is adjustable between 1-24 hours.

SETTING SWITCH OFF TIMER

With the air conditioner operating in any function mode, press the Timer Control button . Then the  Off and the two digits timer indicator will come on. Set the desired time delay OFF hours (1 – 24 hours) by pressing the up or down buttons. When the delay time set has elapsed, the air conditioner will switch off.

To cancel the switch off timer, press the Timer Control button  and set the hour to 00.

SETTING DELAYED SWITCH ON TIMER

When the air conditioner is off, press the Timer Control button . Then the On  and the two digits timer indicator will come on. Set the desired time delay ON hours (1 – 24 hours) by pressing the up or down buttons. When the delay time set has elapsed, the air conditioner will switch on **in the previous setting**.

To cancel the switch on timer, press the Timer Control button  and set the hour to 00.

AUTO RESTART

In the event of a power outage, the air conditioner restarts at the previously set function mode and settings when power is restored.

NOISE LEVEL

Portable air conditioners may make sounds that are not familiar to you. The sounds listed below are normal. Noise reflecting off hard surfaces such as a floor or wall can make the sounds seem louder than they actually are.

- The compressor may make a pulsating or high-pitched sound.
- Water running from the evaporator to the water tank may make a splashing sound.
- Refrigerant flowing may make a gurgling sound.
- Fan sound may come from front and back air vents.

WATER DRAINAGE

The air conditioner has the capacity to dehumidify up to 81 pints per day. The patented self-evaporating function of the unit fully exhausts all condensation automatically in most environments when humidity is less than 70%. Areas with more than 70% humidity, the self-evaporating function can still exhaust about 98% of the moisture and the remaining 2% of moisture will be collected in the water tank of the air conditioner.

When there is excess water condensation inside the unit, the air conditioner stops running and the RED Stop light illuminates. The Stop light indicates that the water condensation needs to be drained manually:

Manual Drainage

1. Turn off the unit.
2. Carefully roll the unit to a drain location or position a flat container, dish or optional drain bucket accessory (sold separately) under the drain area of the lower drain port.
3. Remove the drain cover and rubber plug and the condensed water will drain out automatically.
4. Once all the condensed water is drained, replace the drain rubber plug and cover into the drain firmly.

Continuous Gravity Drainage Option

This option is recommended if uninterrupted operation is desired.

1. Remove the drain plug cover and rubber plug from the upper drain port.
2. Install the drain hose (sold separately) through the drain cover.
3. Thread the drain cover onto the upper drain port.
4. Place the open end of the drain hose downward to an area appropriate for draining.

WARNING: The hose must be directed downward from the upper drain port to allow the condensed water to flow with gravity.

Note: Please contact support@whynter.com for retail sales information or visit whynter.com for a list of optional accessories.

CARE AND MAINTENANCE

IMPORTANT:

- Switch off the air conditioner and disconnect the plug from the power outlet
- Drain water by removing the drain plug.
- Always transport the air conditioner in an upright position only.

CLEANING THE PRE-FILTER

- To ensure the air intake is filtered properly and to assure that your air conditioner runs efficiently, it is recommended to clean the Pre-filter at least once every two weeks.
- Switch off the air conditioner and pull out the filter frame from the unit.
- Remove the Activated Carbon filter from the Pre-filter.
- Use a vacuum cleaner or tap lightly to remove loose dust and dirt from the Pre-filter. Then rinse it thoroughly under warm or cold running water (no hotter than 100°F.)
- Dry thoroughly before re-inserting the filters.
- **NOTE:** The Activated Carbon filter is not washable. It should be replaced every 2-3 months or as needed.

WARNING! Never operate the air conditioner without the filter in place.

CLEANING THE AIR CONDITIONER

- Always switch off the air conditioner and disconnect the plug from the power supply outlet before cleaning the air conditioner.
- Use a soft damp cloth to wipe the body of the unit.
- Never use harsh chemicals, oil-based products, detergents, chemically treated cloths or other cleaning solutions. These could possibly damage the body of the air conditioner.

END OF SEASON STORAGE

This portable air conditioner comes with one end of season storage cover. We highly recommend that storage cover bag is utilized when the unit is not going to be used for a period of time.

WARNING: To avoid danger of suffocation, keep this bag away from babies and children.

- Switch off the air conditioner and disconnect the power plug from the power supply outlet before cleaning the air conditioner.
- Clean the pre-filter.
- Drain the condensed water completely.
- On a warm day, set the unit to Fan only mode for half a day to dry the unit internally.
- Gather the power cord and bundle it.
- Remove the batteries from the remote.
- If leaving the window kit in place, disconnect the exhaust and intake hose from the window slider kit and place the included covers on the fixtures. Otherwise, remove the window kit from the window opening. To remove the hose connectors from the fixtures on the window kit, slightly turn, push and gently pull the connector to release.
- Place the storage cover over the air conditioner.

NOTE:

Depending on use, it is recommended that the air conditioner be cleaned internally annually. Please contact Whynter at support@whynter.com for internal maintenance cleaning instructions.

TIPS:

1. Keep the exhaust hose as short and straight as possible

The exhaust hose removes heat from the room. It should remain as short and straight as possible without sharp bends or twists to maximize efficiency. If the exhaust hose must be extended, do not exceed 9'.

2. Turn the air conditioner on early

Turning the air conditioner on early instead of waiting until the hottest point of the day will allow the unit to be more effective. The air conditioner will not have to work as hard to cool the room down and maintain the set temperature.

3. Reduce heat sources

Direct sunlight, televisions, computers and other heat generating appliances work against the air conditioner by introducing heat into the space.

- Close window curtains and blinds to keep direct sunlight out
- Close doors and windows
- Keep ovens and stoves off
- Turn off unused lights
- Add weather stripping around windows and doors

4. Keep the air filter clean

Regular cleaning will help keep your air conditioner working properly. Dusty filters and vents greatly reduce the airflow and efficiency of the unit.

- Clean the washable pre-filter regularly
- Replace the activated carbon filter every 2-3 months depending on use
- Vacuum any accumulated dust from around all vents

5. Remove the intake hose

Remove the intake hose to prevent the unit from over-working when the outdoor humidity or temperature is high.

TECHNICAL DATA

Model	ARC-131GD
Cooling capacity	13,000 BTU
Power supply	115V / 60Hz
Maximum power input	1050 Watts 9.5 Amps
CEER EER	5.88 8.42
Dehumidifying capacity	91 Pts / Day
Thermostat	61°F to 89°F
Refrigerant	R-410A
Air flow (max.)	320 m ³ / Hour
Unit Dimensions	17.3" W x 15.4" D x 30.5" H
Package Dimensions	20.5" W x 18.8" D x 35" H
Unit Weight	68 lbs
Large Exhaust Hose:	5.9" diameter
Large Hose Connector:	5.9" diameter with 5.0" diameter reducer
Small Intake Hose:	5.0" diameter
Small Hose Connector:	5.0" diameter
Fixture and Window Kit:	5.0" diameter
Window Kit:	6.5" W x 20" (min)/ 46" (max) L

TROUBLESHOOTING

Problem	Possible Causes	Solutions
<p>The portable air conditioner does not turn on</p>	<p>Power failure / outage.</p> <p>The automatic switch, line fuse, or breaker has been tripped.</p> <p>The power supply voltage is too low.</p> <p>The power cord is damaged.</p> <p>The L.C.D.I. power plug for the unit is tripped.</p> <p>The internal water reservoir is full.</p>	<p>Restore the power supply.</p> <p>Flip the switch / change the fuse / turn the breaker back on. Also note that you may have too many appliances drawing power on one circuit, you may need to move the other appliances to another circuit.</p> <p>Move the unit onto another circuit with the correct voltage.</p> <p>Call for service. Only authorized personnel should replace damaged power cord or power plug.</p> <p>Press the Reset button on the L.C.D.I. power plug.</p> <p>Drain water from the air conditioner.</p>
<p>The unit turns on but the compressor does not turn on (the fan runs but the unit is not cooling)</p>	<p>The room temperature is outside of the operational tolerances of the unit.</p> <p>The Cooling mode is not on.</p> <p>The compressor has not turned on yet because of its time delay.</p> <p>The set temperature is too high.</p> <p>The internal water reservoir is full.</p>	<p>This unit is designed to work in ambient temperatures of 64°F to 95°F.</p> <p>Press the MODE button until the COOL light is shown on the display.</p> <p>Give the compressor 3 minutes to turn on after the Cooling mode has been selected.</p> <p>Set the air conditioner to a lower temperature. It is recommended to set the temperature to at least 5°F of the ambient temperature.</p> <p>Either manually drain the water by removing the drain plug or allow the unit to exhaust the water itself by running the fan only mode. Then cooling will resume.</p>
<p>The air coming out of the unit is not very cold, or the airflow volume is weak</p>	<p>The filters are dirty or obstructed.</p> <p>The air intake or exhaust is obstructed.</p> <p>The unit is set in DRY or FAN mode.</p> <p>The unit is set to low fan speed.</p>	<p>Clean the air filters.</p> <p>Make sure there is at least 20" of clearance from the air intake. Make the length of the exhaust hose is as short as possible.</p> <p>Set the unit to the cooling mode.</p> <p>Set the unit to a higher fan speed.</p>

<p>The unit has worked for a long time, but the room is not cold enough</p>	<p>Windows or doors are open.</p> <p>There are too many people in the room.</p> <p>There is direct sunshine into the room.</p> <p>The room is a kitchen or with many heat-producing appliances</p> <p>There is a server in the room.</p> <p>The room is too large.</p>	<p>Close all windows and doors.</p> <p>You may need additional cooling or another air conditioner.</p> <p>Close curtains or blinds and try to minimize the amount of direct sunlight into the room.</p> <p>You may need additional cooling or another air conditioner.</p> <p>You may need additional cooling or another air conditioner.</p> <p>You may need additional cooling or another air conditioner.</p>
<p>The unit is very noisy</p>	<p>The unit is not level.</p> <p>The surface underneath the unit is uneven.</p> <p>Low power voltage.</p>	<p>Make sure the unit is on hard, level and stable surface.</p> <p>Move the unit to a location with a level and hard floor.</p> <p>Make sure the wall outlet and support the required power consumption of the air conditioner and do not use an extension cord.</p>
<p>The unit leaks water</p>	<p>The unit is tilted or not leveled</p> <p>The water tank is full.</p>	<p>Make use the unit is leveled.</p> <p>Drain water from the drain plugs at the back of the air conditioner.</p>
<p>Fan speed cannot be changed</p>	<p>Fan speed differences are not very noticeable</p>	<p>The fan speed difference is not very noticeable when the compressor is on. Try setting the unit to Fan only mode, you should be able to hear the difference between high and low fan speed settings.</p>

ONE YEAR LIMITED WARRANTY & THREE YEAR WARRANTY ON COMPRESSOR

This WHYNTER product is warranted to the original owner, purchased from an authorized Whynter dealer within the 48 U.S. continental states, for one year from the original purchase date against defects in material and workmanship under normal residential usage. Should your WHYNTER product prove defective within one year from the date of purchase, contact Whynter's Customer Support team with the serial number and proof of purchase to make a warranty claim. A Return Authorization number must be issued before returning any parts or products. Parts or products received without a Whynter issued Return Authorization number will be refused. Under this warranty, Whynter will repair or replace any parts found defective with new or remanufactured parts or exchange the defective product with a new, refurbished, or remanufactured product at our discretion. All defective products and parts covered by this warranty will be repaired or replaced on a mail-in basis to Whynter's Service Center. This warranty is not transferable. After the expiration of the warranty, the cost of labor and parts will be the responsibility of the original owner.

The compressor of portable air conditioners is warranted for an additional two years after the one year limited warranty expires from the date of purchase.

Return freight is prepaid by Whynter within two months of purchase. After two months to one year, the customer will be responsible for the return freight cost to Whynter's Service Center. Please package the product carefully in its original packaging to avoid damage in transit. Whynter is not responsible for damage resulting from shipper mishandling or improper packaging. Please retain the original box and packaging materials.

THIS WARRANTY DOES NOT COVER:

- Acts of God, such as fire, flood, hurricanes, earthquakes and tornadoes.
- Improper power supply such as power surge, low voltage, defective household wiring or inadequate fuses.
- Use in commercial or industrial applications.
- Damage, accidental or otherwise, to the product while in the possession of a consumer not caused by a defect in material or workmanship.
- Damage caused by consumer misuse, tampering, lack of maintenance or failure to follow the care and special handling provisions in the instructions.
- Damage to the finish of the case, or other appearance parts caused by wear.
- Damage caused by repairs or alterations to the product by anyone other than authorized by the manufacturer.
- Removal, Replacement Packaging, Freight and Insurance cost for the warranty service.
- Products sold AS IS or from an unauthorized reseller.
- Products that have had their serial numbers removed or defaced.

DISCLAIMER OF IMPLIED WARRANTIES; LIMITATION OF REMEDIES

CUSTOMER'S SOLE AND EXCLUSIVE REMEDY UNDER THIS LIMITED WARRANTY SHALL BE PRODUCT REPAIR OR REPLACEMENT AS PROVIDED HEREIN. CLAIMS BASED ON IMPLIED WARRANTIES, INCLUDING WARRANTIES OF MERCHANTABILITY OR FITNESS FOR A PARTICULAR PURPOSE, ARE LIMITED TO ONE YEAR OR THE SHORTEST PERIOD ALLOWED BY LAW, BUT NOT LESS THAN ONE YEAR. WHYNTER SHALL NOT BE LIABLE FOR CONSEQUENTIAL OR INCIDENTAL DAMAGES SUCH AS PROPERTY DAMAGE AND INCIDENTAL EXPENSES RESULTING FROM ANY BREACH OF THIS WRITTEN LIMITED WARRANTY OR ANY IMPLIED WARRANTY. SOME STATES AND PROVINCES DO NOT ALLOW THE EXCLUSION OR LIMITATION OF INCIDENTAL OR CONSEQUENTIAL DAMAGES, OR LIMITATIONS ON THE DURATION OF IMPLIED WARRANTIES, SO THESE LIMITATIONS OR EXCLUSIONS MAY NOT APPLY TO YOU. THIS WRITTEN WARRANTY GIVES YOU SPECIFIC LEGAL RIGHTS. YOU MAY ALSO HAVE OTHER RIGHTS THAT VARY FROM STATE TO STATE.

The warranty, product contents and specifications are subject to change at any time without notice; please refer to www.whynter.com for the most current information.

Please retain the original proof of purchase.

To register your warranty, please visit www.whynter.com and fill out the online Warranty Registration form. Please be sure to include a copy of your purchase invoice.

To obtain service or information, contact Whynter LLC via email at support@whynter.com or call 866-WHYNTER (866-949-6837).

Copyright © 2023 Whynter LLC
www.whynter.com